



## Pressure Level Transmitter



visit our website

# PRODUCT INTRODUCTION

## FEATURES

1. FineTek Models include: extension cable transducer, Anti-corrosive model, flanged models & pressure transducers.
2. Can be connected to digital panel meters, recorders, PLC, signal controllers.
3. The metal diaphragm is suitable in as weak acid and alkaline liquids or sewage water treatment.
4. Our internal temperature compensation ensures long lasting reliability.
5. Customized flange/screw sizes available.

## THEORY

A pressure sensor is made up of a piezoresistor Wheatstone bridge.

As shown in fig.2, the pressure is applied to the diaphragm and passes through the silicon oil onto the Wheatstone bridge.

When the liquid pressure acts directly on the front face of diaphragm, the Wheatstone bridge will create a differential voltage. This voltage difference will then be amplified to obtain a current signal of 4-20mA. When this current output is connected to an analog meter, we can scale properly to read the level of the applied liquid in a container or a vessel.

The formula used here is:  $P = q \times H$

Where P is pressure, q is pressure constant and H is the level of liquid in a container.

## APPLICATIONS

1. EC1100 is a liquid measurement device which can be used in a variety of environments, including water-agitation environments.
2. EC1200 can withstand high temperature liquid environment.
3. The Standard Flange Type, EC1210 can be used in liquid & gas pressure measurement environments (i.e., mildly corrosive environments).
4. EC1300-1320 type is suitable for measurement of very deep water, such as measurement of reservoirs.
5. EC1500 is suitable for pressure measurement or control devices such as those found in hydraulic and pneumatic machines.

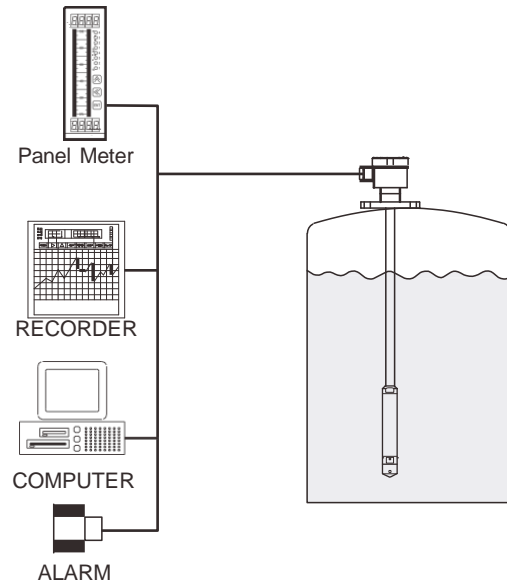

Fig. (1)

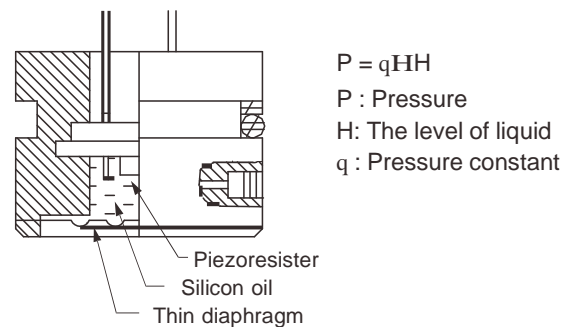
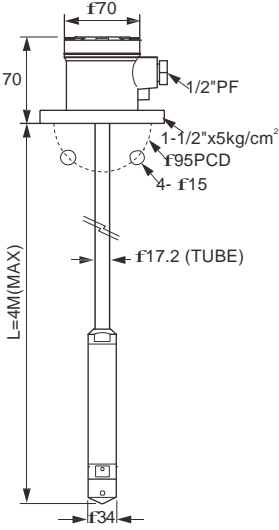
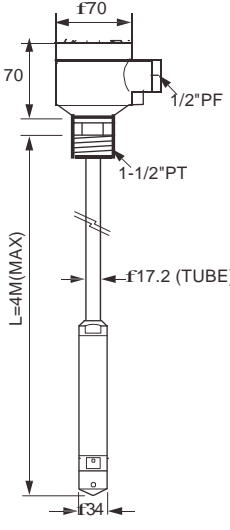
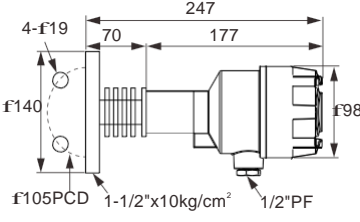

Fig. (2)

# SPECIFICATIONS

<b>Dimensions (unit:mm)</b>			
<b>Model No.</b>	<b>EC1100</b> Extension Tube Flange Model	<b>EC1110</b> Extension Tube Screw Model	<b>EC1200</b> Hi-Temp.Flange Model
<b>Housing material</b>	Aluminum, IP65	Aluminum, IP65	Aluminum, IP65
<b>Pressure range</b>	0.1, 0.2, 0.4 bar	0.1, 0.2, 0.4 bar	0.1, 0.2, 0.5, 1, 2, 5, 10 bar
<b>Measuring range</b>	0~1M,0~2M,0~4M (assumed with the water S.G:1)	0~1M,0~2M,0~4M (assumed with the water S.G:1)	0~1M,0~2M,0~5M,0~10M, 0~20M,0~50M,0~100M (assumed with the water S.G:1)
<b>Linearity</b>	0.3%FS	0.3%FS	0.3%FS
<b>Long term stability</b>	<0.1%	<0.1%	<0.1%
<b>Operating temp</b>	-10~80BC	-10~80BC	-10~150BC
<b>Ambient temp</b>	60BC	60BC	60BC
<b>Supply voltage</b>	13~36 Vdc	13~36 Vdc	13~36 Vdc
<b>Output</b>	4~20mA,Loop resistance should be less than 500 W	4~20mA,Loop resistance should be less than 500 W	4~20mA,Loop resistance should be less than 500 W
<b>Connection</b>	1-1/2" x 5kg/cm <sup>2</sup>	1-1/2" PT	1-1/2" x 10kg/cm <sup>2</sup>
<b>Wetted material</b>	SUS 304/316	SUS 304/316	SUS 304/316
<b>Weight</b>	approx. 4.2kg (L=1M)	approx. 4kg (L=1M)	approx. 1.8kg (L=1M)

※Special size flange and screws are available.

※OEM/ODM is welcome.

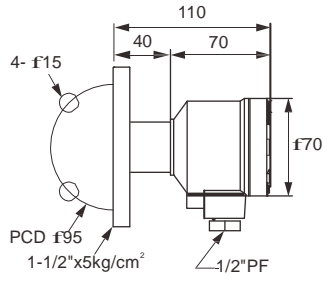
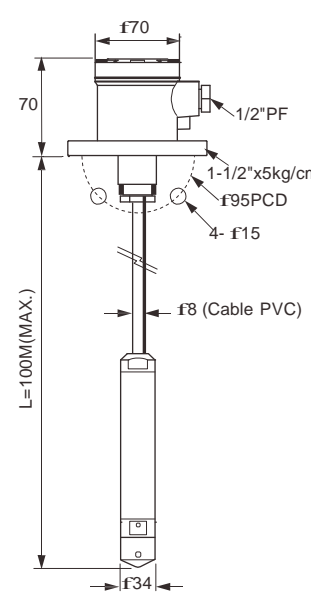
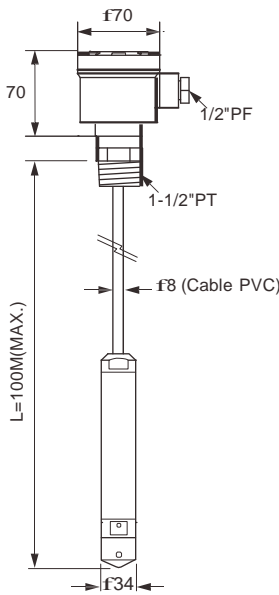
Dimensions (unit:mm)			
<b>Model No.</b>	<b>EC1210 Flange Standard Model</b>	<b>EC1300 Extension Cable Flange Model</b>	<b>EC1310 Extension Cable Screw Model</b>
<b>Housing material</b>	Aluminum, IP65	Aluminum, IP65	Aluminum, IP65
<b>Pressure range</b>	0.1, 0.2, 0.4 bar	0.1, 0.2, 0.5, 1, 2, 5, 10 Bar	0.1, 0.2, 0.4, 1, 2, 5, 10 Bar
<b>Measuring range</b>	0~1M,0~2M,0~4M (assumed with the water S.G:1)	0~1M,0~2M,0~5M,0~10M, 0~20M,0~50M,0~100M (assumed with the water S.G:1)	0~1M,0~2M,0~4M,0~10M, 0~20M,0~50M,0~100M (assumed with the water S.G:1)
<b>Linearity</b>	0.3%FS	0.3%FS	0.3%FS
<b>Long term stability</b>	<0.1%	<0.1%	<0.1%
<b>Operating temp</b>	-10~80°C	-10~80°C	-10~80°C
<b>Ambient temp</b>	60°C	60°C	60°C
<b>Supply voltage</b>	13~36 Vdc	13~36 Vdc	13~36 Vdc
<b>Output</b>	4~20mA,Loop resistance should be less than 500 W	4~20mA,Loop resistance should be less than 500 W	4~20mA,Loop resistance should be less than 500 W
<b>Connection</b>	1-1/2" x 5kg/cm <sup>2</sup>	1-1/2"x5kg/cm <sup>2</sup>	1-1/2"PT
<b>Wetted material</b>	SUS 304/316	SUS 304/316	SUS 304/316
<b>Weight</b>	approx. 1.5kg	approx. 2.8kg (L=1M)	approx. 2.9kg (L=1M)

※Special size flange and screws are available.  
 ※OEM/ODM is welcome.

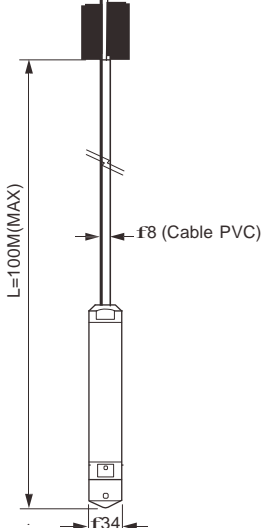
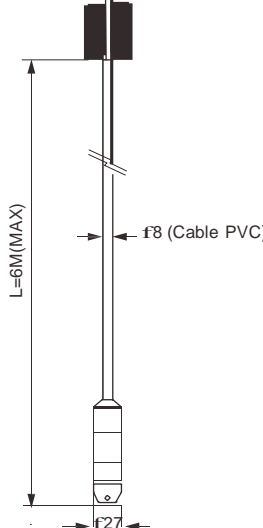
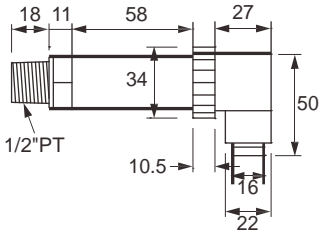
Dimensions (unit:mm)			
<b>Model No.</b>	<b>EC1320 Extension Cable Model</b>	<b>EC2500 Extension Cable Model</b>	<b>EC1500 Pressure Transducer</b>
<b>Pressure range</b>	0.1, 0.2, 0.5, 1, 2, 5, 10 bar	0.25, 0.4, 0.6 bar	0.1, 0.2, 0.5, 1, 2, 5, 10, 20, 50, 100 bar
<b>Measuring range</b>	0~1M, 0~2M, 0~5M, 0~10M, 0~20M, 0~50M, 0~100M (assumed with the water S.G:1)	0~2.5M, 0~4M, 0~6M (assumed with the water S.G:1)	—————
<b>Linearity</b>	0.3%FS	0.3%FS	0.3%FS
<b>Long term stability</b>	<0.1%	<0.1%	<0.1%
<b>Operating temp</b>	-10~80℃	-10~80℃	-10~80℃
<b>Ambient temp</b>	N. A.	N. A.	60℃
<b>Supply voltage</b>	13~36 Vdc	10~30 Vdc	13~36 Vdc
<b>Output</b>	4~20mA, Loop resistance should be less than 500 W	4~20mA, Loop resistance should be less than 500 W	4~20mA, Loop resistance should be less than 500 W
<b>Protection</b>	—————	—————	1/2" PT
<b>Wetted material</b>	SUS 304/316	SUS 316	SUS 304/316
<b>Weight</b>	approx. 0.8kg (L=1M)	approx. 0.8kg (L=1M)	approx. 250g

※Special size flange and screws are available.  
 ※OEM/ODM is welcome.

# INTERNAL WIRING

1. Ensure power is turned off before connecting. See fig.3, 4 or 5 (depending on the model).
2. Make sure the outlet breather capillary is open for air to flow freely.
3. Please tighten the cover and cable gland after the wiring is finished.
4. The cable should be at least 18 AWG or 16 AWG.

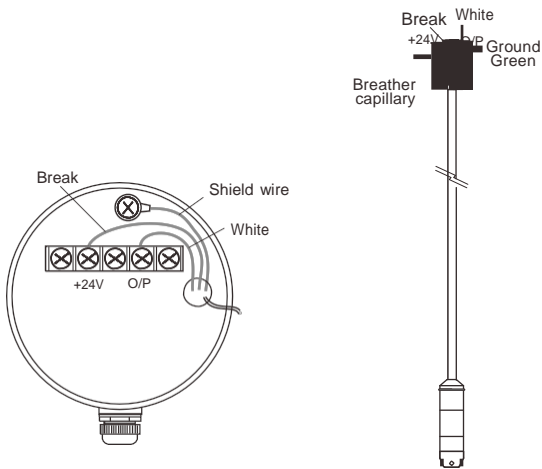

Fig. (3)

EC1100, EC1110, EC1300, EC1310

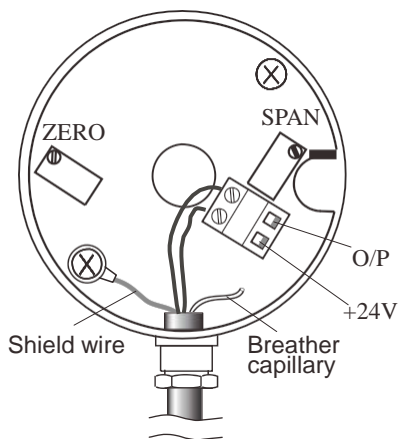

Fig. (4)

EC1200, EC1210

## EC1500 TYPE

1. Remove the cover of plug and connect cable to the terminal of plug.

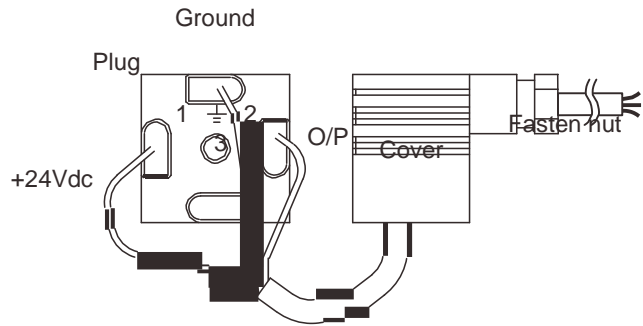

Fig. (5)

2. When wiring is finished, assemble the plug with cover.

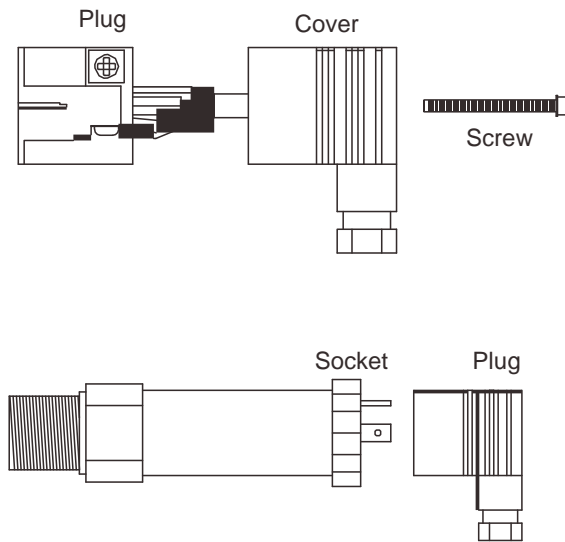

Fig. (6)

# EXTERNAL WIRING

1. When connecting panel meters, please refer to the wiring diagram attached and the related operation manual.
2. Wiring connection should be kept away from high voltage cables, (e.g. power cables) to prevent electrical interference.
3. Operating voltage should be kept higher than 13Vdc.
4. Wiring should be used in shielded insulated cable.
5. Provide additional power supply if required (Diagram 8). If installing 2 panel meters at different location, please refer to diagram 9.

EC1100~1110,1300~1310  
Inside view

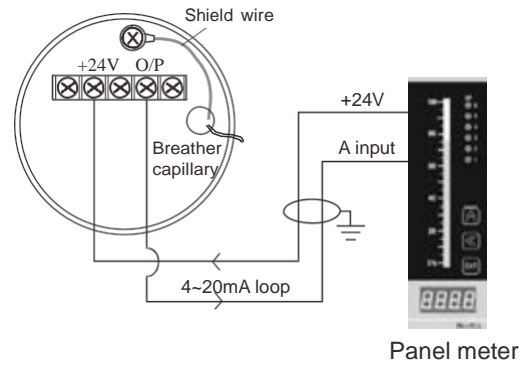

Fig. (7)

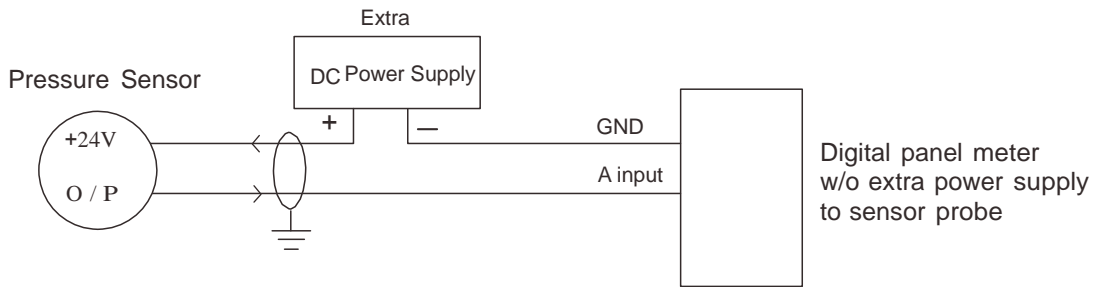

Fig. (8)

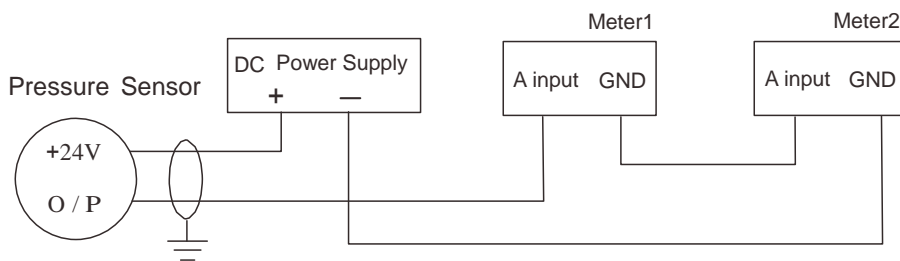
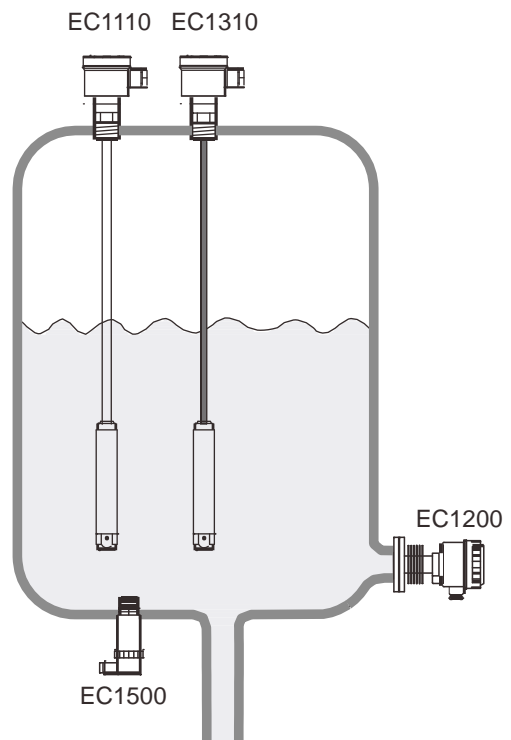
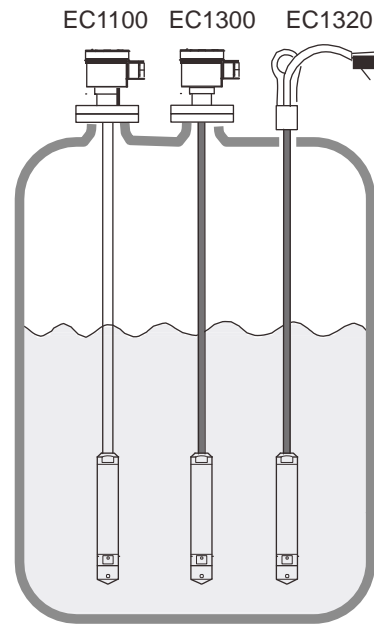

Fig. (9)

## INSTALLATION

1. Note the installation diagrams to the right and select your model accordingly.
2. The flange type transducer is equipped with a side mounted electrical housing.
3. The models EC1100 to EC1310 series have 3 multi-thread copper wires and a breather capillary. Avoid bending cables to ensure maximum accuracy.
4. Do not use liquid that can crystallize or solidify in the pressure transducers and sensors.
5. The tank or vessel should not be vacuum or no pressure state.
8. Handle the sensor probes with care. The sensor probe is delicate and vibration or shock can damage it.
9. Do not use high pressure water jets to wash or contact the sensing diaphragms.





# ADJUSTMENT (FOR ZERO-SPAN)

- 1 Since Zero & Span adjustment have been made in the factory. Don't change the setting unless necessary. Zero represents the 4mA for an empty tank and Span represents the 20mA for a full tank.
- 1 Adjustment range: (SPAN) 18~24mA, (ZERO) 3~5mA.
- 1 In the case where sensor output requires more than the 4~20mA signal, a panel meter with programmable input (0~25.5mA) can be used.

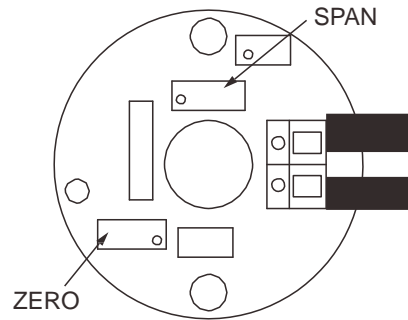

The electrical housing for transducer with flange.

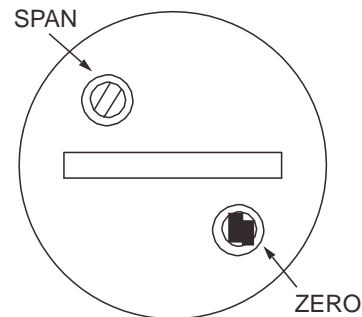

The electrical housing for pressure transducer.

## Pressure Unit Conversion Constants

	PSI	KPa	mbar	cmH <sub>2</sub> O	mmHg	kgf/cm <sup>2</sup>
PSI	1	6.89	68.95	70.31	51.71	70.31x10 <sup>-3</sup>
KPa	0.15	1	10	10.2	7.5	1.02x10 <sup>-2</sup>
mbar	1.45x10 <sup>-2</sup>	0.1	1	1.02	0.75	1.02x10 <sup>-3</sup>
cmH <sub>2</sub> O	14.22x10 <sup>-3</sup>	98.07x10 <sup>-3</sup>	0.98	1	0.74	10 <sup>-3</sup>
mmHg	19.34x10 <sup>-3</sup>	13.33x10 <sup>-2</sup>	1.33	1.36	1	1.36x10 <sup>-3</sup>
kgf/cm <sup>2</sup>	14.22	98.07	980.67	1000	735.56	1

1 MPa=10.2kgf/cm<sup>2</sup>=145 PSI

1 kgf/cm<sup>2</sup>=0.098MPa=14.22 PSI

# HOW TO ORDER

**EC 1 1 0 0 EM (0 1 0 0)**

**MODEL**

110: Extension Tube Flange Type      131: Extension Cable Screw Type  
 111: Extension Tube Screw Type      132: Extension Cable Type  
 130: Extension Cable Flange Type

**WETTED MATERIAL**

0: SUS304      6: SUS316      E: PTFE  
 (EC130 Extension Cable Type)

**PROCESS CONNECTION**

B: 1/2" (15A)	I : 4" (100A)	M: 5 kg/cm <sup>2</sup>	U: NPT
C: 3/4" (20A)	J: 5" (125A)	N: 10 kg/cm <sup>2</sup>	W: PN10 (10Bar)
D: 1" (25A)	K: 6" (150A)	O: 150 Lbs	X: PN16 (16Bar)
E: 1-1/2" (40A)	S: Others	P: 300 Lbs	Y: PN25 (25Bar)
F: 2" (50A)		Q: PT	Z: PN40 (40Bar)
G: 2-1/2" (65A)		R: PF(G)	S: Others
H: 3" (80A)		T: BSP	-.: None

**PROBE LENGTH (unit: mm)**

**0050:** below 500mm  
**0100:** 501~1000mm  
**0150:** 1001~1500mm      ※ 500mm per Unit  
 ⋮

**EC 1 2 0 0 EM 0 1**

**MODEL**

120: Hi-Temp. Flange Type      150: Pressure Transducer(Custom-made)  
 121: Flange Standard Type

**WETTED MATERIAL**

0: SUS304      6: SUS316

**PROCESS CONNECTION**

B: 1/2" (15A)	I : 4" (100A)	M: 5 kg/cm <sup>2</sup>	U: NPT
C: 3/4" (20A)	J: 5" (125A)	N: 10 kg/cm <sup>2</sup>	W: PN10 (10Bar)
D: 1" (25A)	K: 6" (150A)	O: 150 Lbs	X: PN16 (16Bar)
E: 1-1/2" (40A)	S: Others	P: 300 Lbs	Y: PN25 (25Bar)
F: 2" (50A)		Q: PT	Z: PN40 (40Bar)
G: 2-1/2" (65A)		R: PF(G)	S: Others
H: 3" (80A)		T: BSP	-.: None

**PRESSURE RANGE**

X1: 0~0.1bar	X5: 0~0.5bar	05: 0~5bar	50: 0~50bar
X2: 0~0.2bar	01: 0~1bar	10: 0~10bar	A0: 0~100bar
X4: 0~0.4bar	02: 0~2bar	20: 0~20bar	

- \* Total product length tolerance: A5mm
- \* Characteristics, specifications and dimensions are subject to change.
- \* Please contact your nearest distributing office for further informations.

# HOW TO ORDER

EC 2 5 0 0 X 2 5 ( 0 1 0 0 )

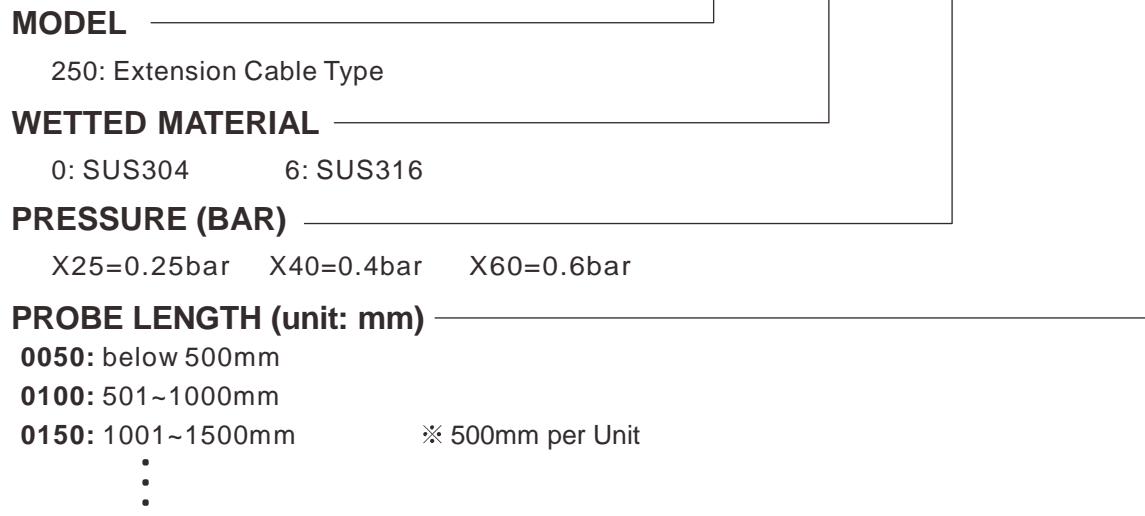

- \* Total product length tolerance: A5mm
- \* Characteristics, specifications and dimensions are subject to change.
- \* Please contact your nearest distributing office for further informations.

# EXAMPLES OF TANK MOUNTING

- [FC/FD] Mini Float/Magnetic Float Level Switch
- [FG] Magnetic Float Level Transmitter
- [FF] Side Mounting Float Switch
- [FA/FB] Cable Float Level Switch
- [SP] Thermal Dispersion Flow Switch
- [SF] Paddle Flow Switch
- [SD] Optical Level Switch
- [SE] Rotary Paddle Level Switch
- [SA] Capacitance Level Switch
- [EC] Pressure Level Transmitter
- [LR] Loop Power Indicator
- [SC] Vibrating Probe Level Switch
- [SC] Tuning Fork Level Switch
- [EB] RF-Capacitance Level Transmitter
- [SB] RF-Capacitance / Admittance Level Switch
- [EG] Magnetostrictive Level Transmitter
- [EF] By-Pass Level Transmitter
- [MEF] Mini By-Pass Level Transmitter
- [EA] Ultrasonic Level Transmitter
- [JFR] FMCW Radar Level Transmitter
- [EE] Electromechanical Level Measuring System
- [ED] Speed Monitor
- [SRT/SRS] Conveyor Belt Misalignment Switch & Safety Cable Pull Switch
- [PB/PM] Microprocessor Based Bargraphic Display Scaling Meter
- [BRD/AE] Valve and Controller for Dust Collector System
- [BAS/BAH/BVP] Air Hammer
- [BVK/BVR/BVT] Pneumatic Vibrator

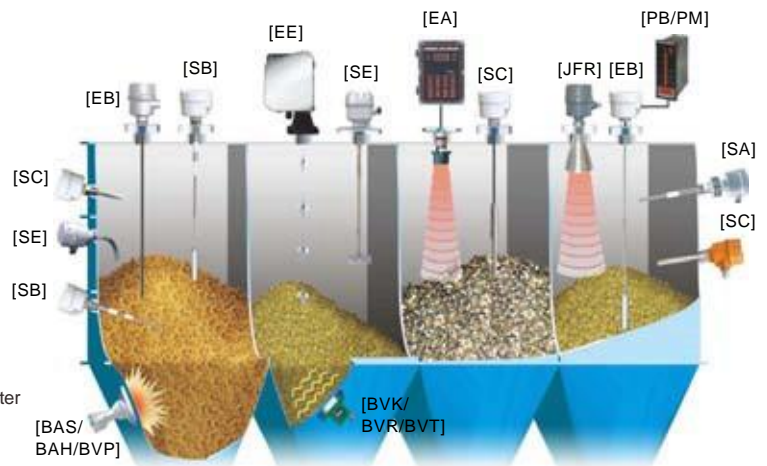
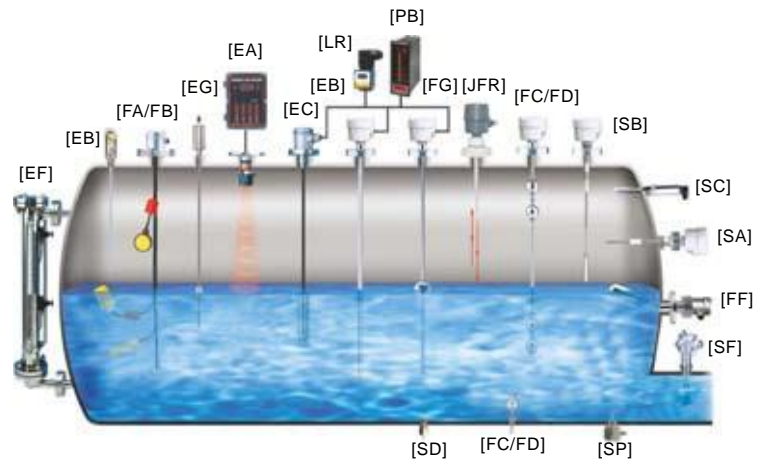

Danmark - Sverige - Norge  
 NivoTech  
 Tlf.: +45 4673 0008  
[www.nivotech.dk](http://www.nivotech.dk)