

# SPECIFICATION

## STRUCTURE & DIMENSION

### 1. Cable

The <HAR> approved cable is extremely flexible to ensure a long life-time.

### 2. Enclosure

The rugged enclosure can prevent the damages from mechanical impact and chemical corrosion. The unit complies with the IP68 enclosure rating.

### 3. Micro switch

Contact system suitable for applications with high in-rush current.

### 4. Steel ball

FAC(CS1-R) A/B/C  
(P.P. float)

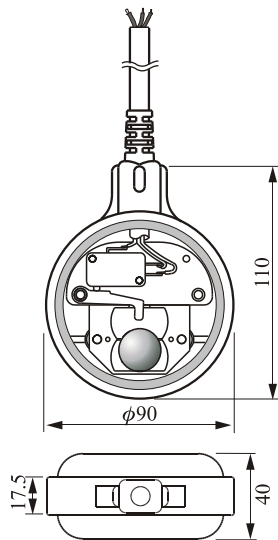

FAR(CS2-R) A/B/C  
FAP(CS2-P) A/B/C  
(P.P. float)  
FAD(CS2-P) A/B/C  
FAE(CS2-P) A/B/C  
(PVC float)

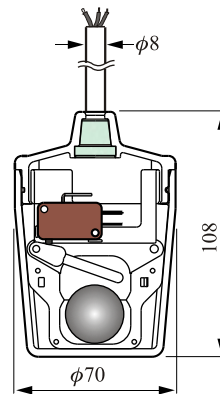

FAS(CF-S) A/B/C  
(SUS float)

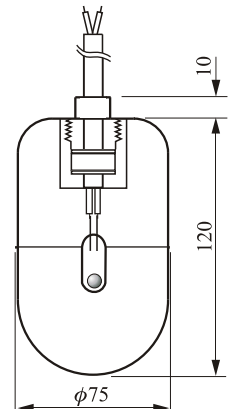

## SPECIFICATION

Type	FAC(CS1-R) A/B/C	FAP(CS2-P) A/B/C	FAR(CS2-R) A/B/C	FAD A/B/C	FAE A/B/C	FAS(CF-S) A/B/C
Float Material	P.P.			PVC		SUS304
Cable Specification	Neoprene Cable 1mm <sup>2</sup> x3C or 2C	PVC Cable 1.25mm <sup>2</sup> x3C or 2C	Neoprene Cable 1mm <sup>2</sup> x3C or 2C	Neoprene Cable 1mm <sup>2</sup> x3C or 2C	PVC Cable 1.25mm <sup>2</sup> x3C or 2C	Silicon Cable 0.75mm <sup>2</sup> x3C or 2C
Contact Rating	10A/250Vac (std.) or 15A/250Vac			10A/250Vac (std.) or 15A/250Vac		2A/250Vac
Contact Form	N.O. N.C. or SPDT			N.O. N.C. or SPDT		N.O. N.C. or SPDT
Operating Temp.	-10°C~80°C	0°C~60°C	-10°C~80°C	-10°C~80°C	0°C~60°C	0°C~170°C
Suitable S.G.	0.6			0.6		0.5
Weight Approx.	770g/5M	290g/1M	290g/1M	290g/1M	290g/1M	480g/5M
Pressure(Max.)	2 kg/cm <sup>2</sup>	2 kg/cm <sup>2</sup>	2 kg/cm <sup>2</sup>	2 kg/cm <sup>2</sup>	2 kg/cm <sup>2</sup>	2 kg/cm <sup>2</sup>

## FLOAT TYPE CODE

(CS1-R)  
FACA□□...PP Float

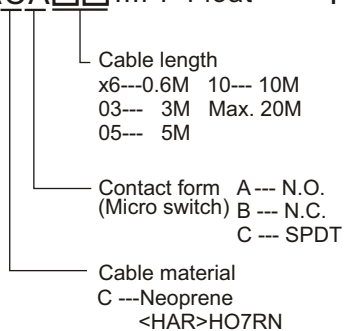

(CS2-P/R)  
FAPA□□...PP Float

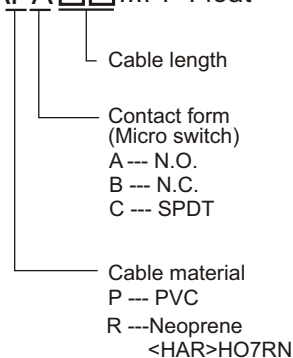

(CF-SA)  
FASA□□...SUS Float

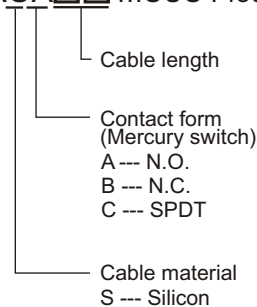

FADA□□...PVC Float

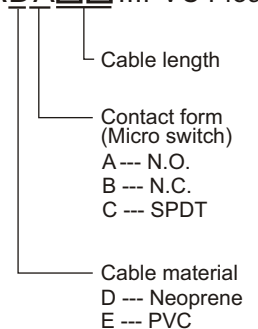

## DIMENSION OF WEIGHT

MODEL: CS-PP-W  
(P.P. Weight)  
Order No. : FAPW-03 (std.)  
FAPW-05  
Weight: 0.3kg (std.)  
0.5kg

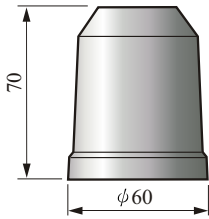

MODEL: CF-SUS-W  
(SUS304 Weight)  
Order No. : FASW  
Weight: 1.8kg

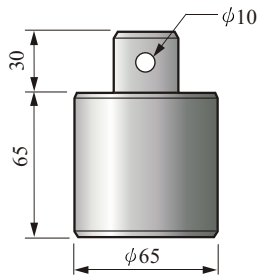

Type	Material	Weight
FAPW-03	PP	0.3kg
FAPW-05		0.5kg
FASW	SUS304	1.8kg

## CONTACT FORM

### ● In Liquid

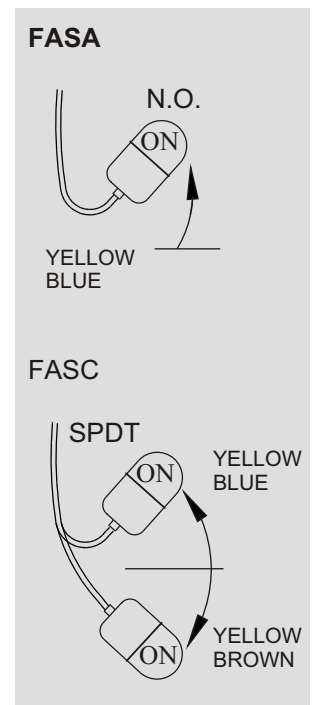
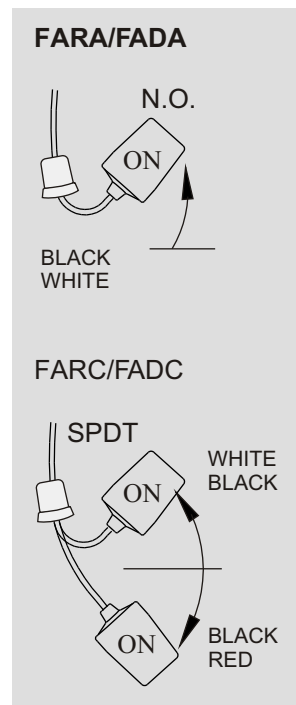
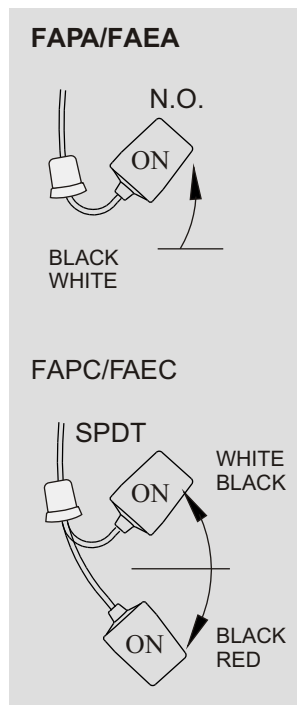
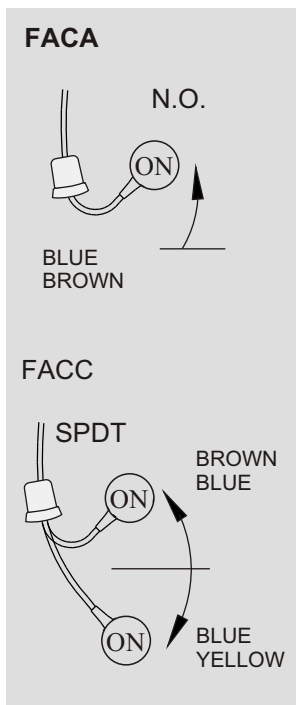

### ● In Air

